

DATA SHEET

Truss-Tower with square 40 x 40cm section and steel lifting sleeveblock operated by electric chain hoist. Cushioned by the vertical tower structure it moves via nylon pulleys.

The 40 x 40cm structure is 6082-T6 aluminium and is constructed with tubular sections, 50mm external diameter with 3.5mm thickness for the main lifting sections and 26mm exterior diameter with 3.5mm thickness for triangular bars. The fixing between sections is carried out with perforated plaques of the same material and fixed with M-16/8.8 screws.

The Towerlift is set on a solid steel base with twisting wheels for the transport and 4 stabiliser legs adjustable depending on work surface. The lifting is done by means of an aluminum cart that slides vertically through nylon guided pulleys on the corners of the vertical structure. Its Fixed plates with screws do the coupling between the sections of the lift.

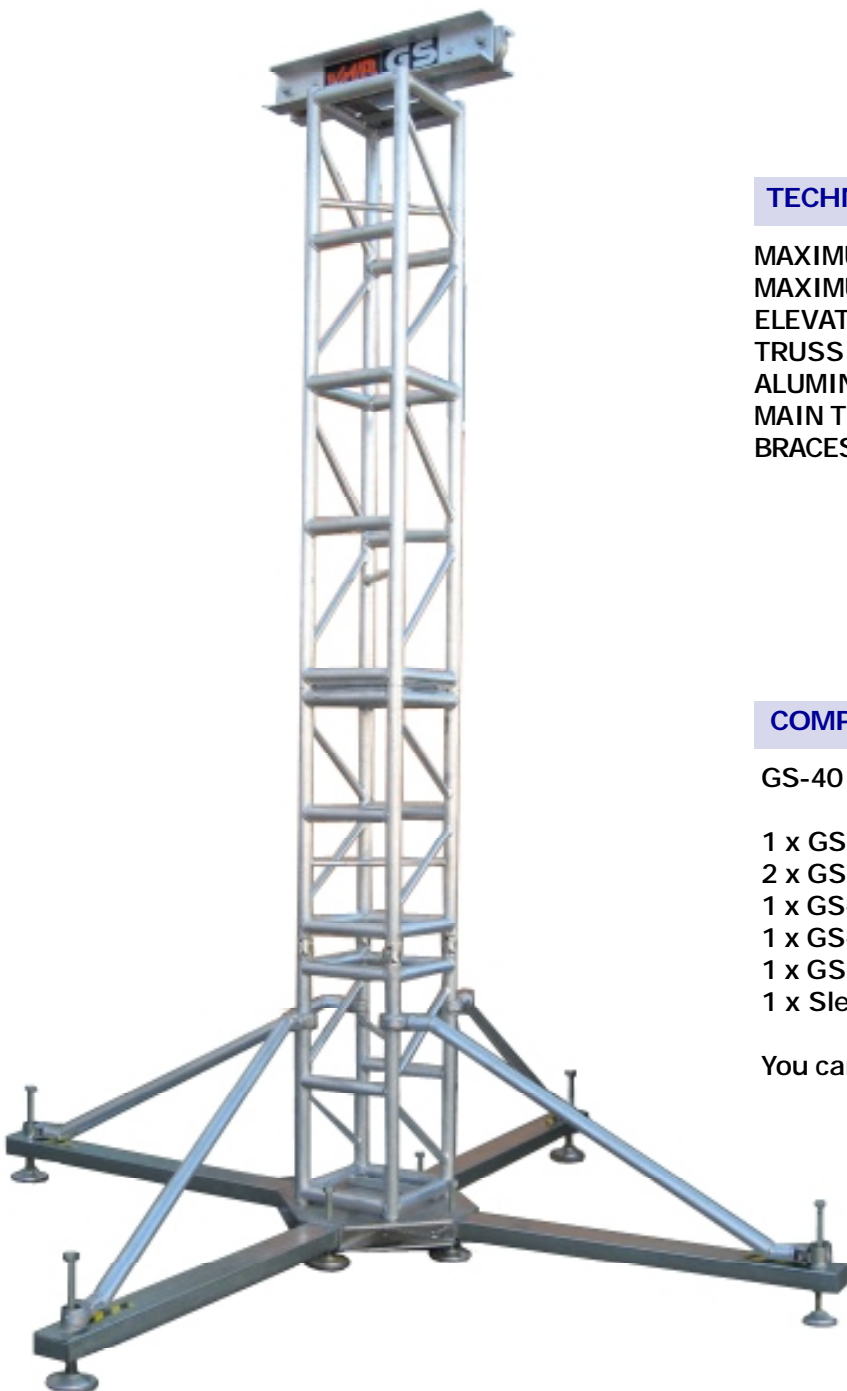

TECHNICAL SPECIFICATIONS

MAXIMUM HEIGHT:	15 m
MAXIMUM LOAD:	3000 Kg
ELEVATION:	HOIST
TRUSS SECTION:	40x40cm
ALUMINIUM ALLOY:	6082 T6
MAIN TUBES:	50 x 3,5mm
BRACES:	26 x 3,5mm

COMPONENTS FOR 9 / 15m

GS-40 /9m	GS-40 /15m
1 x GS-40C	1 x GS-40C
2 x GS-40/TR3	4 x GS-40/TR3
1 x GS-40/TR2B	1 x GS-40/TR2B
1 x GS-40/TR1B	1 x GS-40/TR1B
1 x GS-40B	1 x GS-40B
1 x Sleeveblock	1 x Sleeveblock

You can configure intermediate heights.

GS-40C

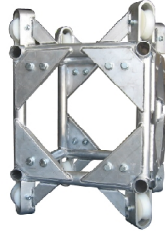
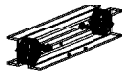

SLEEVE BLOCK

GS-40/52E3	3 ways block for 52x52cm truss
GS-40/52E4	4 ways block for 52x52cm truss
GS-40/76E3	3 ways block for 76x52cm truss
GS-40/76E4	4 ways block for 76x52cm truss

GS-40/TR3

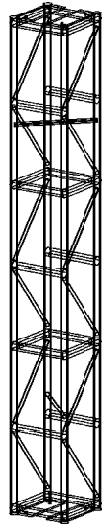

HOIST
(optional)

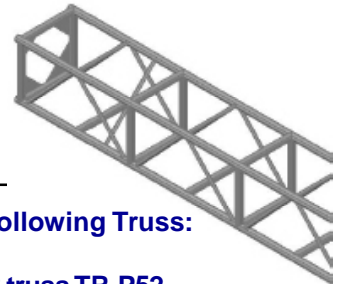

GS-40 can be used with the following Truss:

Square 52x52 cm	VMB truss TR-P52
Folded 52x52 cm	VMB truss TR-P52P
Rectangular 76x52 cm	VMB truss TR-P76
Folded 76x52 cm	VMB truss TR-P76P

GS-40/TR3



LIST OF COMPONENTS:

GS-40C	Top with pulleys
GS-40B	Base
GS-40P	Stabiliser leg
GS-40T	Tight piece for leg
GS-40/TR3	Square truss 3m
GS-40/TR2B	Square truss 2m with hinge
GS-40/TR1B	Square truss 1m with hinge
GS40-TR1	Square truss 1m
GS40-TR2	Square truss 2m
GS40-TR08B	Square truss 0.8m with hinge
GS40-TR08	Square truss 0.8m

Other accessories

SE-GS-12	Ground support assembly helper
SA-G1	Hoist support plaque
1/2C-52M	Hoist bracket
SM-52A	Top support

GS-40/TR2B

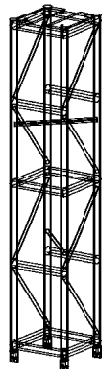

GS-40/TR1B

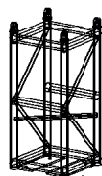

GS-40B



GS-40T

GS-40P

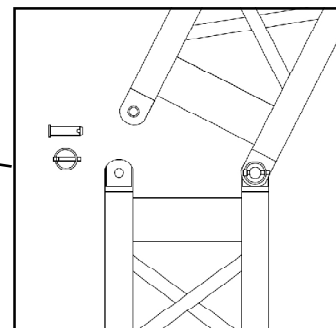

Hinge system for easy assembly

